

4-Line BUS-Port ESD-Protection

20397

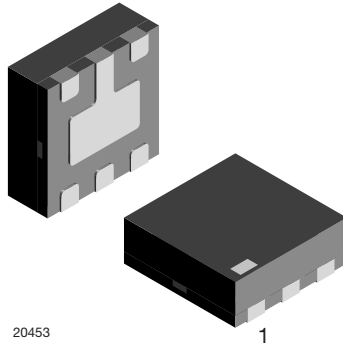
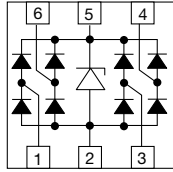

20453

1

MARKING (example only)

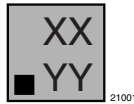

21001

Dot = Pin 1 marking

XX = Date code

YY = Type code (see table below)

FEATURES

- Ultra compact LLP75-6L package
- 4-line USB ESD-protection
- Low leakage current
- Low load capacitance $C_D = 1.2 \text{ pF}$
- ESD-protection acc. IEC 61000-4-2
 $\pm 30 \text{ kV}$ contact discharge
 $\pm 30 \text{ kV}$ air discharge
- High surge current acc. IEC 61000-4-5 $I_{pp} > 11 \text{ A}$
- e4 - precious metal (e.g. Ag, Au, NiPd, NiPdAu), (no Sn)
- Material categorization: for definitions of compliance please see www.vishay.com/doc?99912

RoHS
 COMPLIANT
 HALOGEN
FREE
GREEN
 (5-2008)

ORDERING INFORMATION

DEVICE NAME	ORDERING CODE	TAPED UNITS PER REEL (8 mm TAPE ON 7" REEL)	MINIMUM ORDER QUANTITY
VBUS54CV-HSF	VBUS54CV-HSF-G4-08	3000	15 000

PACKAGE DATA

DEVICE NAME	PACKAGE NAME	TYPE CODE	WEIGHT	MOLDING COMPOUND FLAMMABILITY RATING	MOISTURE SENSITIVITY LEVEL	SOLDERING CONDITIONS
VBUS54CV-HSF	LLP75-6L	UC	4.2 mg	UL 94 V-0	MSL level 1 (according J-STD-020)	260 °C/10 s at terminals

ABSOLUTE MAXIMUM RATINGS VBUS54CV-HSF

PARAMETER	TEST CONDITIONS	SYMBOL	VALUE	UNIT
Peak pulse current	Pin 1, 3, 4 or 6 to pin 2 acc. IEC 61000-4-5; $t_p = 8/20 \mu\text{s}$ /single shot	I_{PPM}	11	A
	Pin 5 to pin 2 acc. IEC 61000-4-5; $t_p = 8/20 \mu\text{s}$; single shot		13	
Peak pulse power	Pin 1, 3, 4 or 6 to pin 2 acc. IEC 61000-4-5; $t_p = 8/20 \mu\text{s}$ /single shot	P_{PP}	242	W
	Pin 5 to pin 2 acc. IEC 61000-4-5; $t_p = 8/20 \mu\text{s}$; single shot		246	
ESD immunity	Contact discharge acc. IEC 61000-4-2; 10 pulses	V_{ESD}	± 30	kV
	Air discharge acc. IEC 61000-4-2; 10 pulses		± 30	
Operating temperature	Junction temperature	T_J	-40 to +125	°C
Storage temperature		T_{STG}	-40 to +150	°C

ELECTRICAL CHARACTERISTICS VBUS54CV-HSF (pin 1, 3, 4, or 6 to pin 2)						
$(T_{amb} = 25\text{ }^{\circ}\text{C}$, unless otherwise specified)						
PARAMETER	TEST CONDITIONS/REMARKS	SYMBOL	MIN.	TYP.	MAX.	UNIT
Protection paths	Number of lines which can be protected	$N_{channel}$	-	-	4	lines
Reverse stand-off voltage	Max. reverse working voltage	V_{RWM}	-	-	5.5	V
Reverse voltage	at $I_R = 0.1\text{ }\mu\text{A}$	V_R	5.5	-	-	V
Reverse current	at $V_{RWM} = 5.5\text{ V}$	I_R	-	0.01	0.1	μA
Reverse breakdown voltage	at $I_R = 1\text{ mA}$	V_{BR}	7	7.9	8.6	V
Reverse clamping voltage	at $I_{PP} = 11\text{ A}$	V_C	-	18	22	V
Forward clamping voltage	at $I_{PP} = 11\text{ A}$	V_F	-	6.5	8	V
Capacitance	V_R (at I/O pin) = 0 V V_R (at pin 5) = 5 V; $f = 1\text{ MHz}$	C_D	-	1.2	2.5	pF
Line symmetry	Difference of the line capacitances	dC_D	-	-	0.2	pF

ELECTRICAL CHARACTERISTICS (pin 5 to pin 2)						
$(T_{amb} = 25\text{ }^{\circ}\text{C}$, unless otherwise specified)						
PARAMETER	TEST CONDITIONS/REMARKS	SYMBOL	MIN.	TYP.	MAX.	UNIT
Reverse stand-off voltage	Max. reverse working voltage	V_{RWM}	-	-	5.5	V
Reverse voltage	at $I_R = 0.1\text{ }\mu\text{A}$; pin 2 to pin 1	V_R	5.5	-	-	V
Reverse current	at $V_{RWM} = 5.5\text{ V}$	I_R	-	0.01	0.1	μA
Reverse breakdown voltage	at $I_R = 1\text{ mA}$	V_{BR}	6.3	7.1	8	V
Reverse clamping voltage	at $I_{PP} = 13\text{ A}$	V_C	-	18	22	V
Forward clamping voltage	at $I_{PP} = 13\text{ A}$	V_F	-	-	7	V
Capacitance	V_R (at pin 5) = 0 V; $f = 1\text{ MHz}$	C_D	-	190	-	pF

APPLICATION NOTE

With the VBUS54CV-HSF a double, high speed USB-port can be protected against transient voltage signals. Negative transients will be clamped close below the ground level while positive transients will be clamped close above the working range. An avalanche diode clamps the supply line (V_{BUS} at pin 5) to ground (pin 2). The high speed data lines, D_{1+} , D_{2+} , D_{1-} and D_{2-} , are connected to pin 1, 3, 4 and 6. As long as the signal voltage on the data lines is between the ground- and the V_{BUS} -level, the low capacitance PN-diodes offer a very high isolation to V_{BUS} , ground and to the other data lines. But as soon as any transient signal exceeds this working range, one of the PN-diodes gets in the forward mode and clamps the transient to ground or the avalanche break through voltage level.

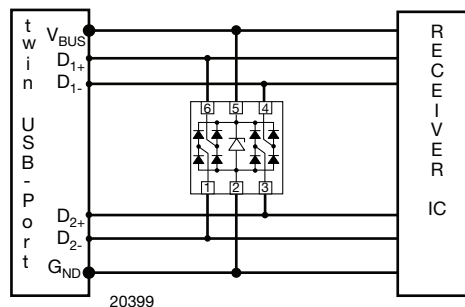

TYPICAL CHARACTERISTICS ($T_{amb} = 25\text{ }^{\circ}\text{C}$, unless otherwise specified)

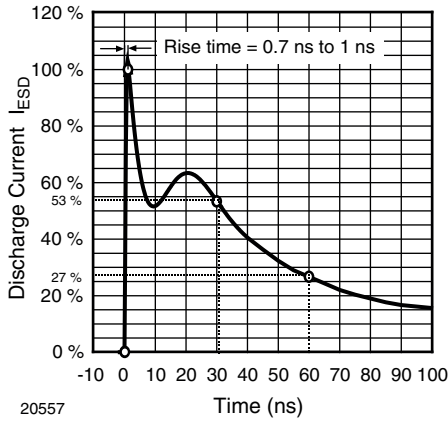

Fig. 1 - ESD Discharge Current Wave Form
acc. IEC 61000-4-2 (330 Ω /150 pF)

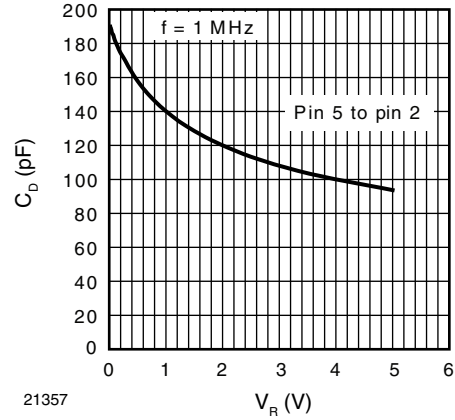

Fig. 4 - Typical Capacitance C_D vs. Reverse Voltage V_R

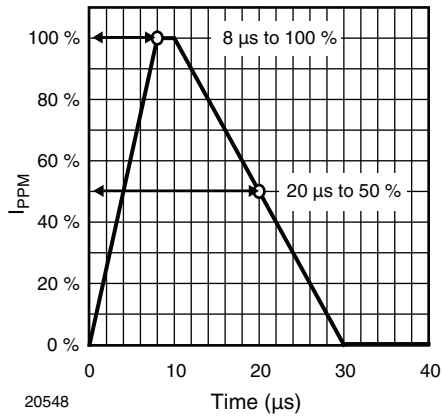

Fig. 2 - 8/20 μs Peak Pulse Current Wave Form
acc. IEC 61000-4-5

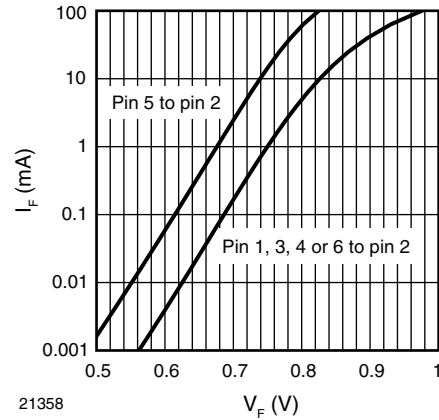

Fig. 5 - Typical Forward Current I_F vs. Forward current I_R

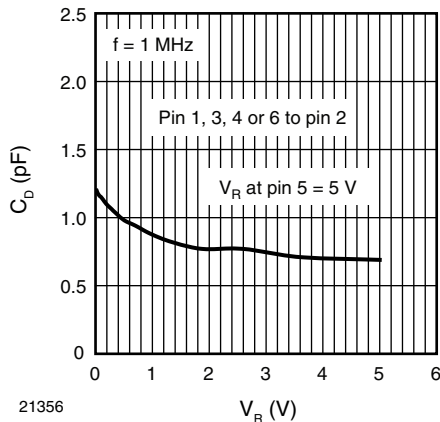

Fig. 3 - Typical Capacitance C_D vs. Reverse Voltage V_R

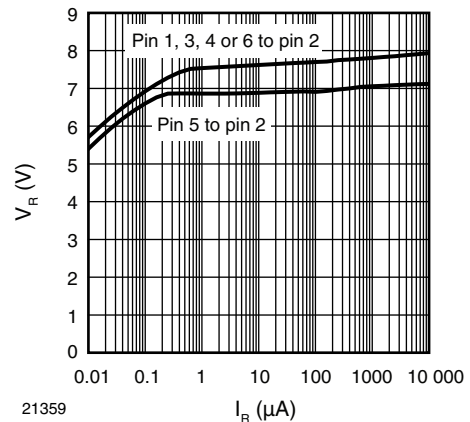

Fig. 6 - Typical Reverse Voltage V_R vs. Reverse Current I_R

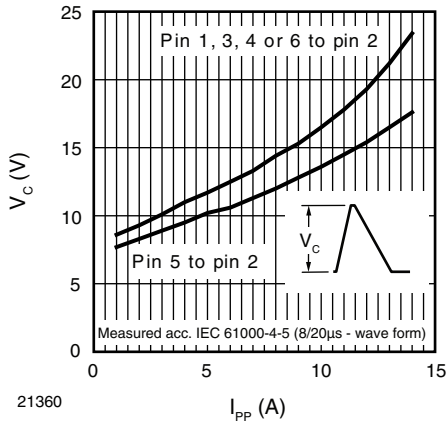

Fig. 7 - Typical Peak Clamping Voltage vs. Peak Pulse Current I_{PP}

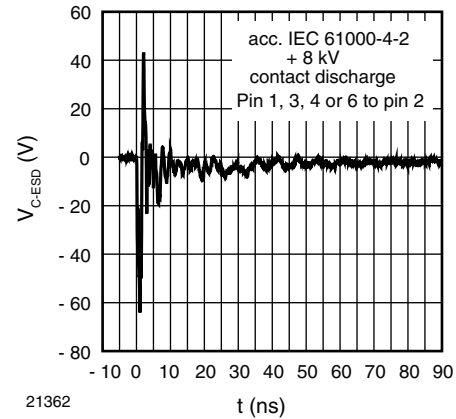

Fig. 9 - Typical Clamping Performance at 8 kV Contact Discharge (acc. IEC 61000-4-2)

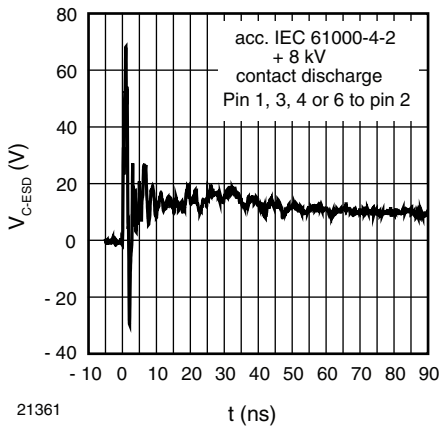

Fig. 8 - Typical Clamping Performance at 8 kV Contact Discharge (acc. IEC 61000-4-2)

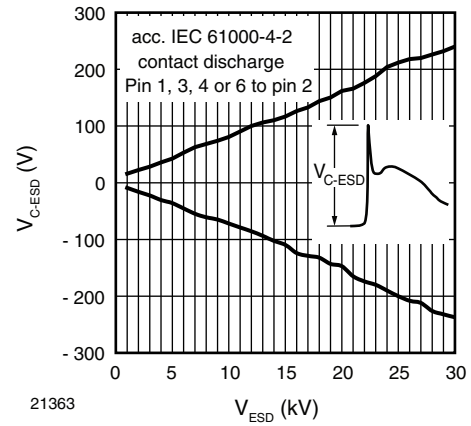
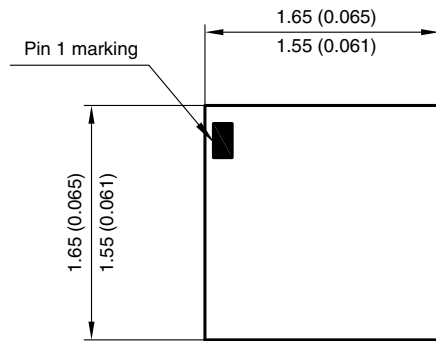
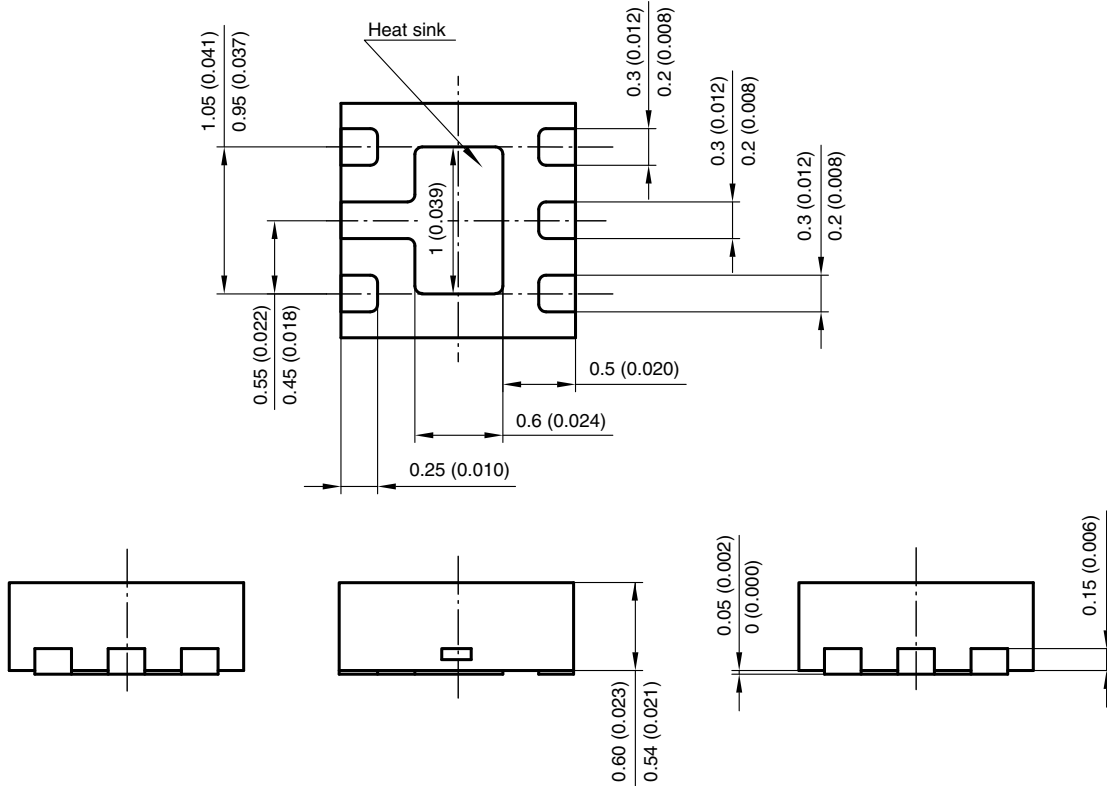

Fig. 10 - Typical Peak Clamping Voltage at ESD Contact Discharge (acc. IEC 61000-4-2)



PACKAGE DIMENSIONS in millimeters (inches): **LLP75-6L**



Foot print recommendation:

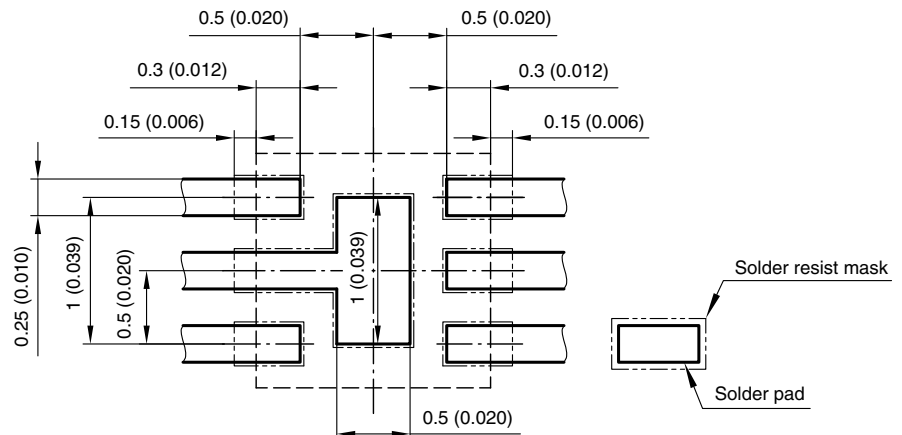

Document no.:S8-V-3906.02-010 (4)
 Created - Date: 04. MAY 2005
 Rev. 4 - Date: 21. March 2006
 20454

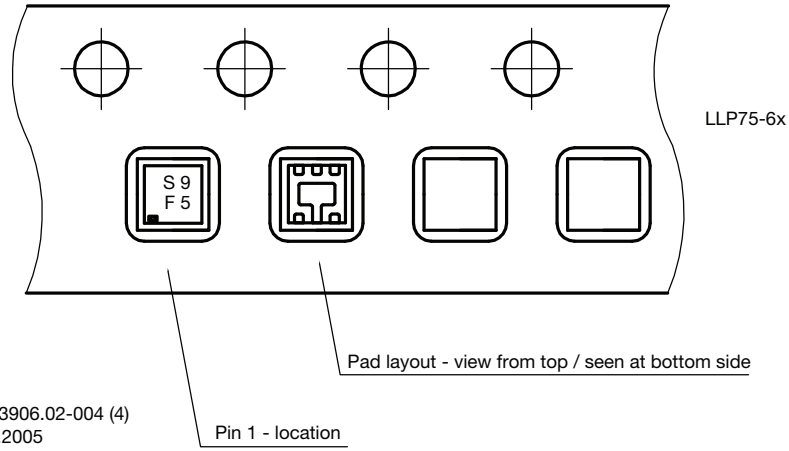



Disclaimer

ALL PRODUCT, PRODUCT SPECIFICATIONS AND DATA ARE SUBJECT TO CHANGE WITHOUT NOTICE TO IMPROVE RELIABILITY, FUNCTION OR DESIGN OR OTHERWISE.

Vishay Intertechnology, Inc., its affiliates, agents, and employees, and all persons acting on its or their behalf (collectively, "Vishay"), disclaim any and all liability for any errors, inaccuracies or incompleteness contained in any datasheet or in any other disclosure relating to any product.

Vishay makes no warranty, representation or guarantee regarding the suitability of the products for any particular purpose or the continuing production of any product. To the maximum extent permitted by applicable law, Vishay disclaims (i) any and all liability arising out of the application or use of any product, (ii) any and all liability, including without limitation special, consequential or incidental damages, and (iii) any and all implied warranties, including warranties of fitness for particular purpose, non-infringement and merchantability.

Statements regarding the suitability of products for certain types of applications are based on Vishay's knowledge of typical requirements that are often placed on Vishay products in generic applications. Such statements are not binding statements about the suitability of products for a particular application. It is the customer's responsibility to validate that a particular product with the properties described in the product specification is suitable for use in a particular application. Parameters provided in datasheets and / or specifications may vary in different applications and performance may vary over time. All operating parameters, including typical parameters, must be validated for each customer application by the customer's technical experts. Product specifications do not expand or otherwise modify Vishay's terms and conditions of purchase, including but not limited to the warranty expressed therein.

Except as expressly indicated in writing, Vishay products are not designed for use in medical, life-saving, or life-sustaining applications or for any other application in which the failure of the Vishay product could result in personal injury or death. Customers using or selling Vishay products not expressly indicated for use in such applications do so at their own risk. Please contact authorized Vishay personnel to obtain written terms and conditions regarding products designed for such applications.

No license, express or implied, by estoppel or otherwise, to any intellectual property rights is granted by this document or by any conduct of Vishay. Product names and markings noted herein may be trademarks of their respective owners.